

brand **McCulloch**

date **21.03.03** Sheet **1/2**

Publication No. **P0303007**

Model

M1033E

Product Number

9647794-01

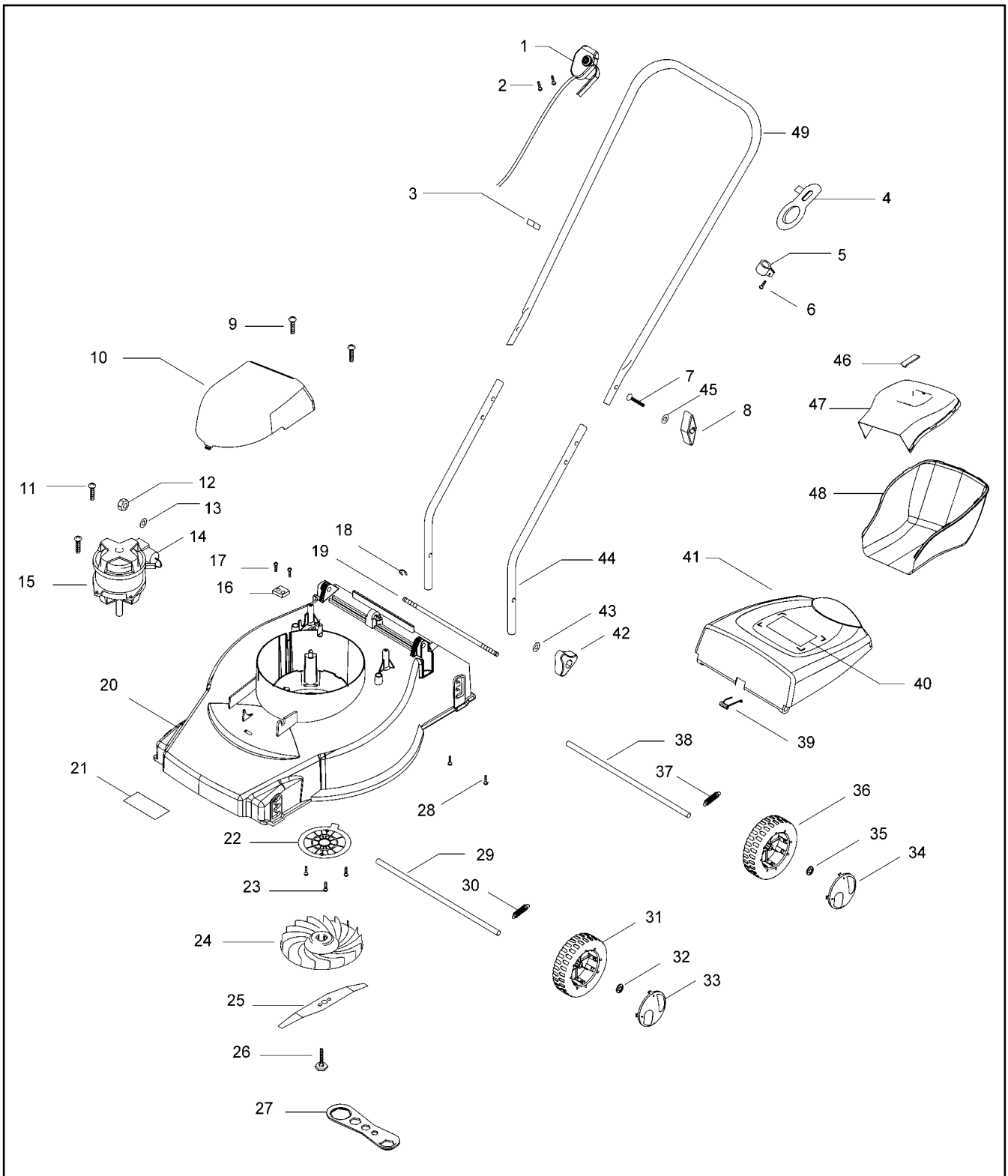

brand	McCulloch
-------	-----------

date	21.03.03	Sheet 2/2
------	----------	-----------

M1033E

pos	Part No	Description	Qty	pos	Part No	Description	Qty
1	5107117-02/9	Kit switchbox	1	37	5312049-79/4	Spring	1
2	5148085-00/3	Screw	2	38	5130971-00/4	Axle	1
3	5138574-00/8	Cable clip	2	39	5312061-39/2	Spring	1
4	5312070-51/8	Cord Guide	1	40	5138587-00/0	Warning label	1
5	5312049-84/3	Locking ring	1	41	5107067-69/5	Safety flap	1
6	5169307-01/3	Screw	1	42	5119565-00/9	Wing knob	2
7	5149198-01/1	Bolt	2	43	5140266-03/1	Washer	2
8	5119563-00/4	Wing knob	2	44	5119470-67/1	Lower Handle	2
9	5149753-01/3	Screw	2	45	5164491-01/0	Washer	2
10	5119398-67/4	Motor cover	1	46	5130980-67/4	Handle grassbox	1
11	5130974-00/8	Screw	2	47	5107064-67/5	Grassbox upper	1
12	5149106-00/6	Nut	1	48	5107066-67/1	Grassbox lower	1
13	5139099-00/5	Toothlock washer	1	49	5119469-67/3	Handle upper	1
14	5131107-06/1	Capacitor motor	1				
		Leroy somer					
	5131107-05/3	Capacitor motor	1				
		Memaf					
15	5119534-00/5	Motor kit	1				
16	5140705-00/4	Clamp	1				
17	5149753-01/3	Screw	2				
18	5131041-00/5	E clip	1				
19	5131038-00/1	Tie rod	1				
20	5107061-69/8	Deck	1				
21	5131052-01/0	Model label	1				
22	5128194-68/4	Finger protection plate	1				
23	5149753-01/3	Screw	3				
24	5119495-00/9	Impeller	1				
25	5119494-00/2	Blade	1				
26	5131064-00/7	Blade bolt	1				
27	5312103-61/6	Spanner	1				
28	5149753-04/7	Screw	2				
29	5130971-00/4	Axle	1				
30	5312049-74/4	Spring	1				
31	5119447-67/9	Wheel	2				
32	5149679-00/2	Starlock Washer	2				
33	5119448-69/3	Hub cap	2				
34	5119446-69/7	Hub cap	2				
35	5149679-00/2	Starlock Washer	2				
36	5119445-67/3	Wheel	2				